

# Mizuno OMOTENASHI Cup Japan

3-5 May 2019 Yuri Honjo City

Men's Doubles 70+ Group A	Boonsak Jackaphan	Tomo Satoshi	Masaharu Koichi	Yusuke Shigeru	W-L	Rank
Boonsak Ponsana (THA) Jackaphan Thanateeratam		○ 21-15 21-14	○ 21-12 21-13	○ 21- 8 21- 9	M 3-0 G 6-0 P 126-71	1
Tomo Kamegamori (JPN) Satoshi Morofusa	× 15-21 14-21		× 12-21 8-21	○ 21-14 21-11	M 1-2 G 2-4 P 91-109	3
Masaharu Okawara (JPN) Koichi Ozaki	× 12-21 13-21	○ 21-12 21- 8		○ 21-14 21- 7	M 2-1 G 4-2 P 109-83	2
Yusuke Wada (JPN) Shigeru Katano	× 8-21 9-21	× 14-21 11-21	× 14-21 7-21		M 0-3 G 0-6 P 63-126	4

Men's Doubles 70+ Group B	Pracha Rungsun	Kazuhiro Hirofumi	Tadawo Hiroyuki	Masayoshi Motohiro	W-L	Rank
Pracha Wannawichitr (THA) Rungsun Tipsotikul		× 13-21 12-21	○ 21- 8 21- 8	× 16-21 15-21	M 1-2 G 2-4 P 98-100	3
Kazuhiro Ide (JPN) Hirofumi Fujino	○ 21-13 21-12		○ 21-11 21-11	○ 15-21 21-15 22-20	M 3-0 G 6-1 P 142-103	1
Tadawo Kikuchi (JPN) Hiroyuki Yano	× 8-21 8-21	× 11-21 11-21		× 9-21 9-21	M 0-3 G 0-6 P 56-126	4
Masayoshi Ono (JPN) Motohiro Sasajima	○ 21-16 21-15	× 21-15 15-21 20-22	○ 21- 9 21- 9		M 2-1 G 5-2 P 140-107	2

## Men's Doubles 70+ Final Tournament

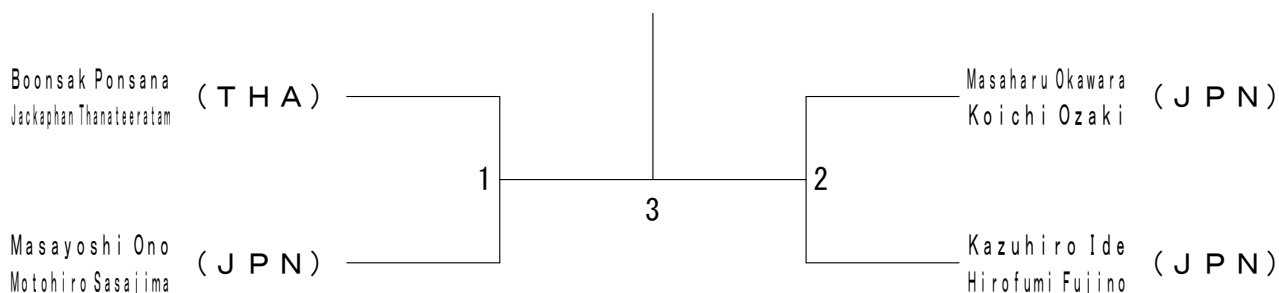

# Mizuno OMOTENASHI Cup Japan

3-5 May 2019 Yuri Honjo City

Men's Doubles 80+ Group A	Yuki Josemari	Takashi Jun	Hiroaki Susumu	Sen So	W-L	Rank
Yuki Nakamura (HKG) Josemari Fujimoto (JPN)		○ 21-19 21-11	○ 21- 6 21- 3	○ 21- 5 21-12	M 3-0 G 6-0 P 126-56	1
Takashi Ogawa (JPN) Jun Yato (JPN)	× 19-21 11-21		○ 21- 4 21-11	○ 21- 1 21- 6	M 2-1 G 4-2 P 114-64	2
Hiroaki Kobayashi (JPN) Susumu Yamada (JPN)	× 6-21 3-21	× 4-21 11-21		× 15-21 15-21	M 0-3 G 0-6 P 54-126	4
Sen Tsuchiya (JPN) So Tsuchiya (JPN)	× 5-21 12-21	× 1-21 6-21	○ 21-15 21-15		M 1-2 G 2-4 P 66-114	3

Men's Doubles 80+ Group B	Hiromasa Hideo	Tatsuya Atsushi	Toshikazu Hideyuki	Tomoya Keiichi	Yutaka Yusuke	W-L	Rank
Hiromasa Akutsu (JPN) Hideo Oyama (JPN)		× 18-21 18-21	○ 21-11 21-16	○ 18-21 21-14 21-19	○ 21-14 21- 8	M 3-1 G 6-3 P 180-145	2
Tatsuya Shimizu (JPN) Atsushi Tasaka (JPN)	○ 21-18 21-18		○ 21-10 21-11	○ 21-18 14-21 21-16	○ 21-17 21- 8	M 4-0 G 8-1 P 182-137	1
Toshikazu Kojima (JPN) Hideyuki Yokoyama (JPN)	× 11-21 16-21	× 10-21 11-21		× 19-21 6-21	○ 21-11 21- 6	M 1-3 G 2-6 P 115-143	4
Tomoya Jin (JPN) Keiichi Tanaka (JPN)	× 21-18 14-21 19-21	× 18-21 21-14 16-21	○ 21-19 21- 6		○ 21- 4 21- 7	M 2-2 G 6-4 P 193-152	3
Yutaka Magara (JPN) Yusuke Yamaguchi (JPN)	× 14-21 8-21	× 17-21 8-21	× 11-21 6-21	× 4-21 7-21		M 0-4 G 0-8 P 75-168	5

## Men's Doubles 80+ Final Tournament

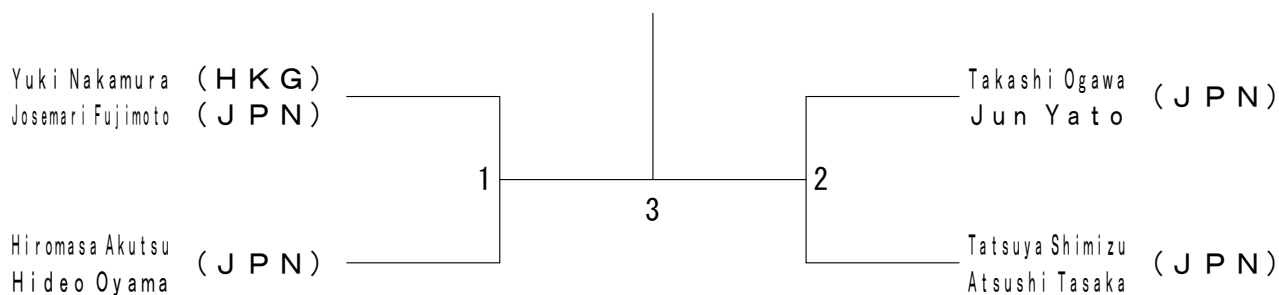

# Mizuno OMOTENASHI Cup Japan

3-5 May 2019 Yuri Honjo City

Men's Doubles 90+ Group A	Naruenart Naruthum	TAM TANG	Manabu Masakazu	Takuya Naoki	W-L	Rank
Naruenart Chuaymak Naruthum Surakkhaka (THA)		○ 21-11 21-9	○ 21-15 21-16	○ 21-8 21-9	M 3-0 G 6-0 P 126-68	1
TAM CHIU MAN CHARLES TANG SIMON YAU SHING (HKG)	× 11-21 9-21		× 14-21 9-21	○ 15-21 25-23 21-9	M 1-2 G 2-5 P 104-137	3
Manabu Sugiura Masakazu Rokutan (JPN)	× 15-21 16-21	○ 21-14 21-9		○ 21-4 21-14	M 2-1 G 4-2 P 115-83	2
Takuya Shimazaki Naoki Hayashi (JPN)	× 8-21 9-21	× 21-15 23-25 9-21	× 4-21 14-21		M 0-3 G 1-6 P 88-145	4

Men's Doubles 90+ Group B	Chatchai Supachai	HUANG WONG	Takeshi Jo	JAFREE TAN	Takenori Yasuharu	W-L	Rank
Chatchai Boonmee Supachai Pintuwat (THA)		○ 21-15 21-19	○ 21-13 21-13	○ 21-8 21-16	○ 21-10 21-6	M 4-0 G 8-0 P 168-100	1
HUANG Hu (CHN) WONG Shu Ching (HKG)	× 15-21 19-21		○ 21-15 20-22 21-13	× 11-21 18-21	○ 21-13 21-14	M 2-2 G 4-5 P 167-161	3
Takeshi Takayanagi Jo Nakamura (JPN)	× 13-21 13-21	× 15-21 22-20 13-21		× 18-21 9-21	○ 21-19 21-12	M 1-3 G 3-6 P 145-177	4
JAFREE BIN RAMLY TAN TIEAN HOW (MAS)	× 8-21 16-21	○ 21-11 21-18	○ 21-18 21-9		○ 21-15 21-8	M 3-1 G 6-2 P 150-121	2
Takenori Kagitani Yasuharu Hirakawa (JPN)	× 10-21 6-21	× 13-21 14-21	× 19-21 12-21	× 15-21 8-21		M 0-4 G 0-8 P 97-168	5

## Men's Doubles 90+ Final Tournament

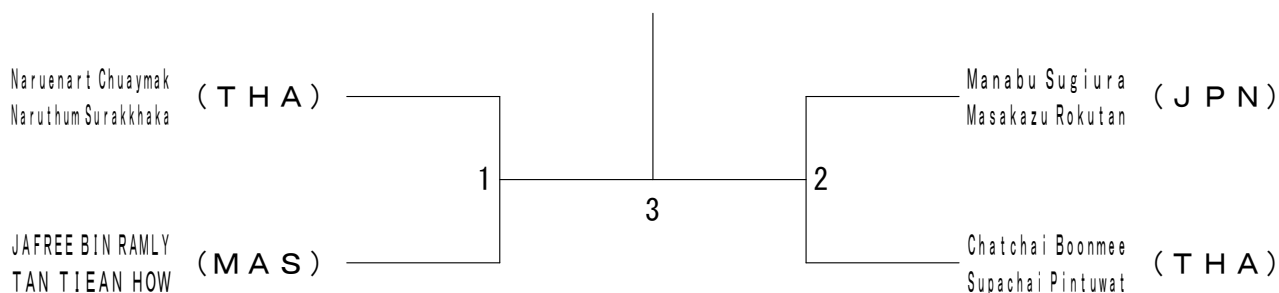

# Mizuno OMOTENASHI Cup Japan

3-5 May 2019 Yuri Honjo City

Men's Doubles 100+ Group A	Wattana Wittaya	Toshiaki Takeshi	WANG YANG	Masaharu Tomohiko	W-L	Rank
Wattana Ampunswan Wittaya Panomchai (THA)		○ 21-12 15-21 21-13	○ 21- 2 21- 5	○ 21-11 20-22 21-19	M 3-0 G 6-2 P 161-105	1
Toshiaki Nakajima Takeshi Masaoka (JPN)	x 12-21 21-15 13-21		○ 21-10 21- 7	x 16-21 16-21	M 1-2 G 3-4 P 120-116	3
WANG YU WEN YANG WEN ZHAO (CHN)	x 2-21 5-21	x 10-21 7-21		x 11-21 7-21	M 0-3 G 0-6 P 42-126	4
Masaharu Ito Tomohiko Goto (JPN)	x 11-21 22-20 19-21	○ 21-16 21-16	○ 21-11 21- 7		M 2-1 G 5-2 P 136-112	2

Men's Doubles 100+ Group B	Toshiaki Kotaro	Aroonprasertkul Koji	XIONG X U	Kenji Tatsuyoshi	Tatsuya Tsutomu	W-L	Rank
Toshiaki Ichii Kotaro Shiraki (JPN)		○ 20-22 21-13 21-10	○ -x	○ 21- 2 21-12	○ 21- 4 21- 7	M 4-0 G 8-1 P 188-70	1
Aroonprasertkul Chetsada Koji Tanaka (THA)	x 22-20 13-21 10-21		○ -x	○ 21-11 21-15	○ 21-19 21-19	M 3-1 G 7-2 P 171-126	2
XIONG ZHOU XU ZHI JIAN (CHN)	x x-	x x-		x x-	x x-	M 0-4 G 0-8 P 0-168	5
Kenji Arashi Tatsuyoshi Mase (JPN)	x 2-21 12-21	x 11-21 15-21	○ -x		x 10-21 12-21	M 1-3 G 2-6 P 104-126	4
Tatsuya Ono Tsutomu Takano (JPN)	x 4-21 7-21	x 19-21 19-21	○ -x	○ 21-10 21-12		M 2-2 G 4-4 P 133-106	3

## Men's Doubles 100+ Final Tournament

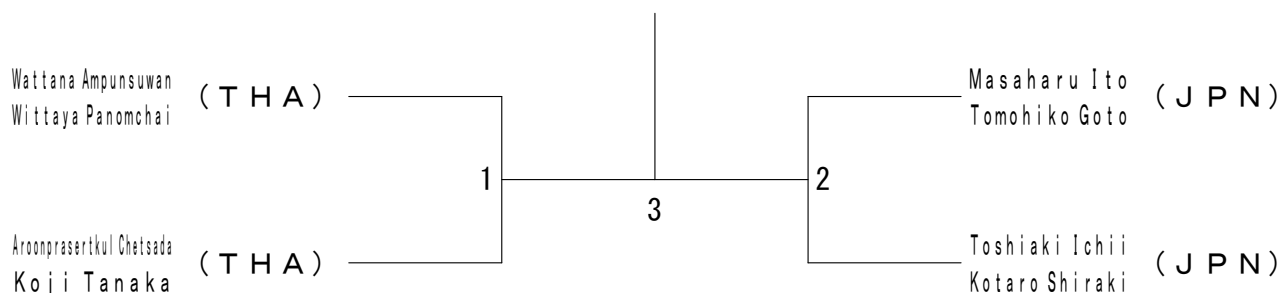

# Mizuno OMOTENASHI Cup Japan

3-5 May 2019 Yuri Honjo City

Men's Doubles 110+ Group A	Bovornovadep Surachai	Masato Akira	S o S i t	T A N Kwan	A N G WONG	W - L	Rank
Bovornovadep Devakula Surachai Makkasasithorn ( T H A )		○ 21-10 21-17	○ 21-18 21-11	○ 21- 8 21- 9	× 11-21 21-14 17-21	M 3-1 G 7-2 P 175-129	2
Masato Sato Akira Chiba ( J P N )	× 10-21 17-21		× 21-18 18-21 8-21	○ 21-10 21-11	× 6-21 18-21	M 1-3 G 3-6 P 140-165	4
So Kam Hoo Sit Wai Keung ( H K G )	× 18-21 11-21	○ 18-21 21-18 21- 8		○ 21-12 21- 9	× 11-21 21-16 13-21	M 2-2 G 5-5 P 176-168	3
TAN KIAT HOCK Kwan Sai Wing Louis ( M A S ) ( H K G )	× 8-21 9-21	× 10-21 11-21	× 12-21 9-21		× 7-21 10-21	M 0-4 G 0-8 P 76-168	5
ANG SOO CHENG WONG KONG KAY ( S I N )	○ 21-11 14-21 21-17	○ 21- 6 21-18	○ 21-11 16-21 21-13	○ 21- 7 21-10		M 4-0 G 8-2 P 198-135	1

Men's Doubles 110+ Group B	Wong Chu	Masayuki Syuichi	Y A N YANG	Johnson Kazuyuki	W - L	Rank
Wong Shu Yuen Chu Siu Keung ( H K G )		× 12-21 21-17 12-21	○ 21-14 21-14	○ 21- 7 21-11	M 2-1 G 5-2 P 129-105	2
Masayuki Fujisawa Syuichi Matsuo ( J P N )	○ 21-12 17-21 21-12		○ 21-17 21-10	○ 21- 5 19-21 21-13	M 3-0 G 6-2 P 162-111	1
YAN JIANPING YANG QIANG ( C H N )	× 14-21 14-21	× 17-21 10-21		○ 21-10 20-22 21-16	M 1-2 G 2-5 P 117-132	3
Johnson Tad Kazuyuki Tano ( J P N )	× 7-21 11-21	× 5-21 21-19 13-21	× 10-21 22-20 16-21		M 0-3 G 2-6 P 105-165	4

Men's Doubles 110+ Group C	Tsang Lam	Hideo Hiroshi	Daniel Thomas	Liao Cheong	W - L	Rank
Tsang Ki Man Lam Wang Chung ( H K G )		○ 21- 9 21-13	○ 21-14 21- 6	○ 21- 6 21-15	M 3-0 G 6-0 P 126-63	1
Hideo Aikawa Hiroshi Kato ( J P N )	× 9-21 13-21		× 16-21 21- 9 18-21	○ 19-21 22-20 21-19	M 1-2 G 3-5 P 139-153	3
Daniel Wang Thomas Lui ( U S A )	× 14-21 6-21	○ 21-16 9-21 21-18		○ -x	M 2-1 G 4-3 P 113-97	2
Liao Wei Cheong Kam Choi ( M A C )	× 6-21 15-21	× 21-19 20-22 19-21	× x-		M 0-3 G 1-6 P 81-146	4

## Men's Doubles 110+ Final Tournament

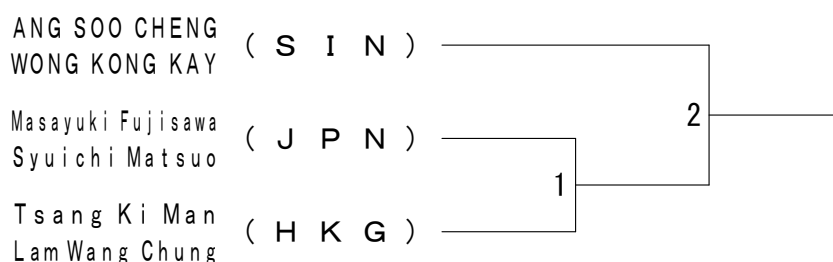

# Mizuno OMOTENASHI Cup Japan

3-5 May 2019 Yuri Honjo City

Men's Doubles 120+ Group A	Nattapol Pravit	Toshiyuki Toru	TAN VICTOR	Koji Tadashi	W-L	Rank
Nattapol Sanlekanun (THA) Pravit Puangsupang		○ 21-8 21-14	○ 16-21 21-16 23-21	○ 21-2 21-3	M 3-0 G 6-1 P 144-85	1
Toshiyuki Kakehata (JPN) Toru Miyano	x 8-21 14-21		x 12-21 21-15 19-21	○ 21-4 21-2	M 1-2 G 3-4 P 116-105	3
TAN KIAN BAN (SIN) VICTOR SIM	x 21-16 16-21 21-23	○ 21-12 15-21 21-19		○ 21-2 21-5	M 2-1 G 5-3 P 157-119	2
Koji Ichiki (JPN) Tadashi Tamura	x 2-21 3-21	x 4-21 2-21	x 2-21 5-21		M 0-3 G 0-6 P 18-126	4

Men's Doubles 120+ Group B	Cheong Liang	Akio Kyoichi	LIE LIM	Kazuharu Takeyoshi	W-L	Rank
Cheong Kam Choi (MAC) Liang Zhi Xiong		x 19-21 20-22	○ 21-12 21-13	x 21-23 6-21	M 1-2 G 2-4 P 108-112	3
Akio Sugawara (JPN) Kyoichi Yamamoto	○ 21-19 22-20		○ 21-17 21-13	x 19-21 21-15 8-21	M 2-1 G 5-2 P 133-126	2
LIE JUN MEN (SIN) LIM CHOONG KHAI	x 12-21 13-21	x 17-21 13-21		x 17-21 6-21	M 0-3 G 0-6 P 78-126	4
Kazuharu Suda (JPN) Takeyoshi Tanimura	○ 23-21 21-6	○ 21-19 15-21 21-8	○ 21-17 21-6		M 3-0 G 6-1 P 143-98	1

Men's Doubles 120+ Group C	Qin Liu	Masaaki Mitsumasa	ONG ZEE	Makoto Tomomi	W-L	Rank
Qin Xiong Hui (MAC) Liu Lin Shan		○ 21-15 21-7	x 8-21 8-21	○ 21-16 21-19	M 2-1 G 4-2 P 100-99	2
Masaaki Aoike (JPN) Mitsumasa Negishi	x 15-21 7-21		x 4-21 9-21	x 14-21 14-21	M 0-3 G 0-6 P 63-126	4
ONG THEN LIN (MAS) ZEE JEFFREY JAMIN (HKG)	○ 21-8 21-8	○ 21-4 21-9		○ 21-15 21-12	M 3-0 G 6-0 P 126-56	1
Makoto Ataka (JPN) Tomomi Chigusa	x 16-21 19-21	○ 21-14 21-14	x 15-21 12-21		M 1-2 G 2-4 P 104-112	3

## Men's Doubles 120+ Final Tournament



# Mizuno OMOTENASHI Cup Japan

3-5 May 2019 Yuri Honjo City

Men's Doubles 130+ Group A	Attakorn Seri	Makoto Masaki	Chua Goh	Gu Pan	W-L	Rank
Attakorn Maensamut Seri Chintanaseri (THA)		○ 21-16 21-12	○ 21-7 23-25 21-7	○ 21-8 21-10	M 3-0 G 6-1 P 149-85	1
Makoto Goto Masaki Furuhashi (JPN)	x 16-21 12-21		○ 26-24 21-19	○ 21-8 21-11	M 2-1 G 4-2 P 117-104	2
Chua Koh Keong Goh Kim Chuan (MAS)	x 7-21 25-23 7-21	x 24-26 19-21		○ 21-10 21-12	M 1-2 G 3-4 P 124-134	3
Gu Yang Xiang Pan Jia Long (MAC)	x 8-21 10-21	x 8-21 11-21	x 10-21 12-21		M 0-3 G 0-6 P 59-126	4

Men's Doubles 130+ Group B	Chongsak Pongsilpa	Jiamsak Prapatana	Lim Sng	CHEN XIE	Boon Kazuo	W-L	Rank
Chongsak Suvanich Pongsilpa Ritipong (THA)		○ -x	○ 21-15 21-17	○ 21-10 21-6	○ 21-9 21-9	M 4-0 G 8-0 P 168-66	1
Jiamsak Panitchaikul Prapatana Vasavid (THA)	x x-		○ 21-11 21-10	○ 21-8 21-12	○ 21-6 21-4	M 3-1 G 6-2 P 126-93	2
Lim yow song Sng Chee Hui (MAS)	x 15-21 17-21	x 11-21 10-21		○ 19-21 21-14 21-9	○ 21-17 21-16	M 2-2 G 4-5 P 156-161	3
CHEN AN ZE XIE LUN LI (SIN)	x 10-21 6-21	x 8-21 12-21	x 21-19 14-21 9-21		○ 21-15 15-21 21-13	M 1-3 G 3-7 P 137-194	4
Boon S Teoh (AUS) Kazuo Saito (JPN)	x 9-21 9-21	x 6-21 4-21	x 17-21 16-21	x 15-21 21-15 13-21		M 0-4 G 1-8 P 110-183	5

## Men's Doubles 130+ Final Tournament

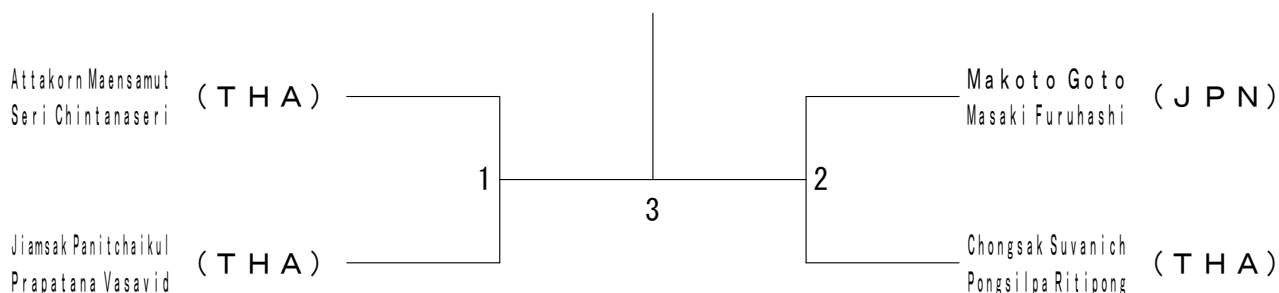

# Mizuno OMOTENASHI Cup Japan

3-5 May 2019 Yuri Honjo City

Women's Doubles 70+	Naomi Y u i	C H E N Sayaka	Y u k a M i k i	S i r i r a t M i w a k o	W - L	Rank
Naomi Akutsu ( J P N ) Yui Minagawa ( J P N )		x x-	x x-	x x-	M 0-3 G 0-6 P 0-126	4
C H E N L i l i ( C H N ) Sayaka Nunome ( J P N )	○ -x		○ 21-15 21-14	○ 21-15 21-14	M 3-0 G 6-0 P 126-58	1
Yuka Ishikawa ( J P N ) Miki Kitamura ( J P N )	○ -x	x 15-21 14-21		x 21-14 20-22 23-25	M 1-2 G 3-4 P 135-103	3
Sirirat Wannawichitr ( T H A ) Miwako Moriyama ( J P N )	○ -x	x 15-21 14-21	○ 14-21 22-20 25-23		M 2-1 G 4-3 P 132-106	2

Women's Doubles 80+ G r o u p A	Ritsuko Y u k o	Miyuki N o r i k o	Y u m i R y o k o	J u n k o N o r i k o	W - L	Rank
Ritsuko Ishibashi ( J P N ) Yuko Hirukawa ( J P N )		○ 21-13 23-25 21-10	○ 21-12 21- 4	○ 21- 5 21- 3	M 3-0 G 6-1 P 149-72	1
Miyuki Kusanagi ( J P N ) Noriko Sanada ( J P N )	x 13-21 25-23 10-21		○ 21- 5 21-10	○ 21-10 21- 8	M 2-1 G 5-2 P 132-98	2
Yumi Otsuka ( J P N ) Ryoko Hongo ( J P N )	x 12-21 4-21	x 5-21 10-21		○ 21-10 21-13	M 1-2 G 2-4 P 73-107	3
Junko Murai ( J P N ) Noriko Wada ( J P N )	x 5-21 3-21	x 10-21 8-21	x 10-21 13-21		M 0-3 G 0-6 P 49-126	4

Women's Doubles 80+ G r o u p B	A i k o K a o r i	K a o r u S a n a e	M a k i A y u m i	K u m i k o M i c h i k a	W - L	Rank
Aiko Miyamura ( J P N ) Kaori Mori ( J P N )		○ 21-15 21-11	○ 21-13 21-12	○ 21-12 21-15	M 3-0 G 6-0 P 126-78	1
Kaoru Takeuchi ( J P N ) Sanae Tamura ( J P N )	x 15-21 11-21		x 12-21 21-18 17-21	x 18-21 21-23	M 0-3 G 1-6 P 115-146	4
Maki Jin ( J P N ) Ayumi Takakura ( J P N )	x 13-21 12-21	○ 21-12 18-21 21-17		○ 21-18 21-18	M 2-1 G 4-3 P 127-128	2
Kumiko Sakamoto ( J P N ) Michika Yanase ( J P N )	x 12-21 15-21	○ 21-18 23-21	x 18-21 18-21		M 1-2 G 2-4 P 107-123	3

## Women's Doubles 80+ Final Tournament

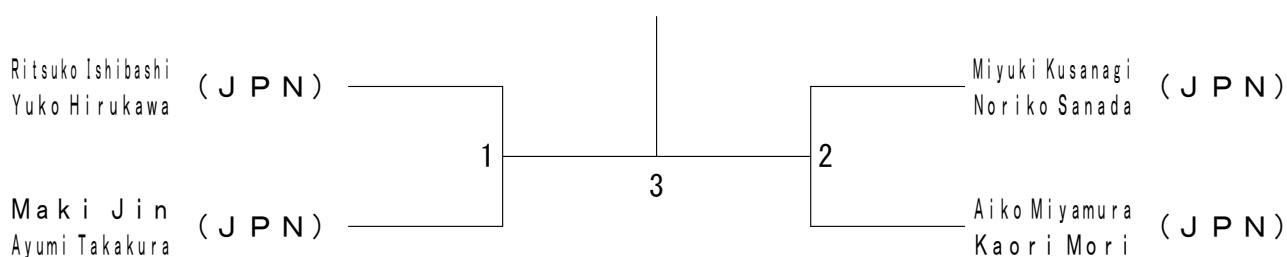



# Mizuno OMOTENASHI Cup Japan

3-5 May 2019 Yuri Honjo City

Women's Doubles 90+	Manami Noriko	Sachiko Miyuki	Cheryl Kok	Tomomi Rie	Shino Mitsue	W-L	Rank
Manami Ito Noriko Ushigome (JPN)		○ 21-10 21-18	× 13-21 13-21	× 15-21 16-21	× 17-21 14-21	M 1-3 G 2-6 P 130-154	4
Sachiko Oka Miyuki Monobe (JPN)	× 10-21 18-21		× 5-21 6-21	× 9-21 13-21	× 9-21 21-14 6-21	M 0-4 G 1-8 P 97-182	5
Cheryl Goh Kok Chan Kong (MAS)	○ 21-13 21-13	○ 21- 5 21- 6		○ 21-18 21-16	○ 21-15 22-20	M 4-0 G 8-0 P 169-106	1
Tomomi Nakatsuki Rie Yasuda (JPN)	○ 21-15 21-16	○ 21- 9 21-13	× 18-21 16-21		○ 21-11 21-14	M 3-1 G 6-2 P 160-120	2
Shino Ito Mitsue Tanaka (JPN)	○ 21-17 21-14	○ 21- 9 14-21 21- 6	× 15-21 20-22	× 11-21 14-21		M 2-2 G 4-5 P 158-152	3

# Mizuno OMOTENASHI Cup Japan

3-5 May 2019 Yuri Honjo City

Women's Doubles 100+ Group A	Kumiko Ritsuko	Kwok Chow	Liao Zhao	Rumiko Miyuki	W - L	Rank
Kumiko Kushiyama ( J P N ) Ritsuko Sato		○ 21- 8 21- 4	○ -x	○ 21- 5 21- 7	M 3-0 G 6-0 P 126-24	1
Kwok Chi Ping ( H K G ) Chow Shuk Han	x 8-21 4-21		○ -x	x 15-21 21-18 15-21	M 1-2 G 3-4 P 105-102	3
Liao Na Ling ( M A C ) Zhao Hui mei	x x-	x x-		x x-	M 0-3 G 0-6 P 0-126	4
Rumiko Saito ( J P N ) Miyuki Shinta	x 5-21 7-21	○ 21-15 18-21 21-15	○ -x		M 2-1 G 4-3 P 114-93	2

Women's Doubles 100+ Group B	Yumiko Chika	CHAN Ikuko	Zhou Lin	Mayumi Koko	W - L	Rank
Yumiko Takeda ( J P N ) Chika Tanifuji		○ 21- 3 21- 8	○ 21-19 21- 2	○ 21- 8 21-12	M 3-0 G 6-0 P 126-52	1
CHAN SIU YING ( H K G ) Ikuko Tsujino ( J P N )	x 3-21 8-21		x 13-21 5-21	x 27-25 21-23 15-21	M 0-3 G 1-6 P 92-153	4
Zhou Jian Yang ( M A C ) Lin Gui Chen	x 19-21 2-21	○ 21-13 21- 5		○ 21-15 21- 9	M 2-1 G 4-2 P 105-84	2
Mayumi Sasakawa ( J P N ) Koko Sasaki	x 8-21 12-21	○ 25-27 23-21 21-15	x 15-21 9-21		M 1-2 G 2-5 P 113-147	3

Women's Doubles 100+ Group C	Miharu Akiko	Cheung Lee	LIEW LIU	Ayumi Yoko	W - L	Rank
Miharu Inoue ( J P N ) Akiko Sato		x 8-21 14-21	○ 21-10 21-17	x 12-21 17-21	M 1-2 G 2-4 P 93-111	3
Cheung Yuk Lin Jenny ( H K G ) Lee Miu Nei Winnie	○ 21- 8 21-14		○ 21-14 21- 4	○ 21-15 21-15	M 3-0 G 6-0 P 126-70	1
LIEW SAM FAH ( S I N ) LIU YALIAN	x 10-21 17-21	x 14-21 4-21		x 12-21 14-21	M 0-3 G 0-6 P 71-126	4
Ayumi Asai ( J P N ) Yoko Hara	○ 21-12 21-17	x 15-21 15-21	○ 21-12 21-14		M 2-1 G 4-2 P 114-97	2

Women's Doubles 100+ Group D	Shinobu Sugako	CHENG MA	TANG WANG	Angela Juthatip	Masae Yasuko	W - L	Rank
Shinobu Okada ( J P N ) Sugako Keisyu		○ 21- 3 21- 3	○ 21- 1 21- 1	○ 21- 6 21- 4	○ 21- 6 21- 2	M 4-0 G 8-0 P 168-26	1
CHENG LAI KAM ( H K G ) MAK WAI FONG	x 3-21 3-21		○ 21-16 21- 6	x 21-10 3-21 9-21	x 22-20 10-21 18-21	M 1-3 G 4-6 P 131-178	4
TANG RONG ( C H N ) WANG HONG	x 1-21 1-21	x 16-21 6-21		○ -x	x 13-21 13-21	M 1-3 G 2-6 P 92-126	5
Angela Charumilinda ( T H A ) Juthatip Banjongsilp	x 6-21 4-21	○ 10-21 21- 3 21- 9	x x-		○ 21- 8 21- 9	M 2-2 G 4-5 P 104-134	3
Masae Otani ( J P N ) Yasuko Okamoto	x 6-21 2-21	○ 20-22 21-10 21-18	○ 21-13 21-13	x 8-21 9-21		M 2-2 G 4-5 P 129-160	2

## Women's Doubles 100+ Final Tournament

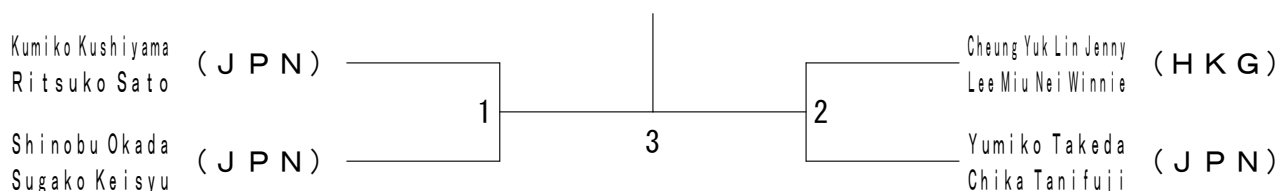

# Mizuno OMOTENASHI Cup Japan

3-5 May 2019 Yuri Honjo City

Women's Doubles 110+ Group A	Wakako Mayumi	WANG WANG	Sanae Mariko	Yoko Ikumi	W-L	Rank
Wakako Otsuka Mayumi Miura ( J P N )		○ 21-13 21-12	× 11-21 14-21	○ 21-15 24-22	M 2-1 G 4-2 P 112-104	2
WANG GUI CHAI WANG ( S I N )	× 13-21 12-21		× 5-21 4-21	× 6-21 7-21	M 0-3 G 0-6 P 47-126	4
Sanae Tanifuji Mariko Numazawa ( J P N )	○ 21-11 21-14	○ 21- 5 21- 4		○ 21-15 21-18	M 3-0 G 6-0 P 126-67	1
Yoko Kanagami Ikumi Tatesawa ( J P N )	× 15-21 22-24	○ 21- 6 21- 7	× 15-21 18-21		M 1-2 G 2-4 P 112-100	3

Women's Doubles 110+ Group B	Hiromi Ryoko	LIU YANG	Yayoi Emiko	Naomi Yumiko	W-L	Rank
Hiromi Takeda Ryoko Yanagimura ( J P N )		× 17-21 13-21	○ 21-14 21-18	○ 21-17 12-21 21-19	M 2-1 G 4-3 P 126-131	3
LIU CHUN HUA YANG WEN LAN ( S I N )	○ 21-17 21-13		○ 21-13 21-11	× 22-20 16-21 13-21	M 2-1 G 5-2 P 135-116	1
Yayoi Kabutoya Emiko Watanabe ( J P N )	× 14-21 18-21	× 13-21 11-21		× 11-21 4-21	M 0-3 G 0-6 P 71-126	4
Naomi Itagaki Yumiko Sato ( J P N )	× 17-21 21-12 19-21	○ 20-22 21-16 21-13	○ 21-11 21- 4		M 2-1 G 5-3 P 161-120	2

Women's Doubles 110+ Group C	Masumi Shinobu	NATALIE YU	Atsushi Junko	Shoko Seiko	W-L	Rank
Masumi Obara Shinobu Sato ( J P N )		○ 21- 5 21- 7	○ 21- 8 21-16	○ 21- 8 21- 7	M 3-0 G 6-0 P 126-51	1
NATALIE ONG LAY GUAT YU LAN ( S I N )	× 5-21 7-21		× 7-21 8-21	× 12-21 19-21	M 0-3 G 0-6 P 58-126	4
Atsushi Sasaki Junko Matsumoto ( J P N )	× 8-21 16-21	○ 21- 7 21- 8		○ 21-17 21- 7	M 2-1 G 4-2 P 108-81	2
Shoko Akimoto Seiko Saruta ( J P N )	× 8-21 7-21	○ 21-12 21-19	× 17-21 7-21		M 1-2 G 2-4 P 81-115	3

## Women's Doubles 110+ Final Tournament

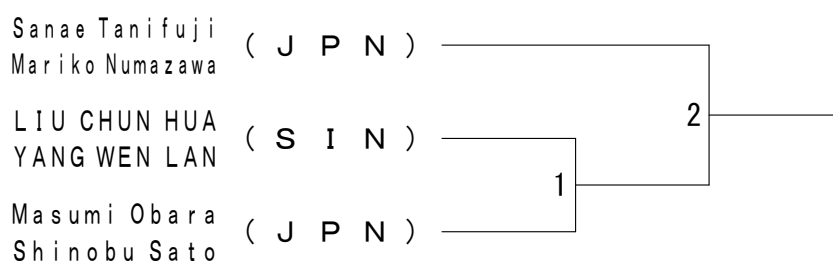

# Mizuno OMOTENASHI Cup Japan

3-5 May 2019 Yuri Honjo City

Women's Doubles 120+ Group A	Sugako Kuniko	Chen Liu	L I N W O O D	W-L	Rank
Sugako Morita (JPN) Kuniko Yamamoto		O 21-5 21-1	O 21-6 21-7	M 2-0 G 4-0 P 84-19	1
Chen Hui Ai (MAC) Liu Xi Ling	x 5-21 1-21		x 21-14 9-21 19-21	M 0-2 G 1-4 P 55-98	3
LIN XUEMEI (CHN) WOOD IRENE POHLENG (AUS)	x 6-21 7-21	O 14-21 21-9 21-19		M 1-1 G 2-3 P 69-91	2

Women's Doubles 120+ Group B	Ikuko Sayoko	L a m N g	KWOK Michiko	W-L	Rank
Ikuko Ito (JPN) Sayoko Sasaki		O 21-10 21-5	O 21-14 21-9	M 2-0 G 4-0 P 84-38	1
Lam Fung Sheung (HKG) Ng Kit Ching	x 10-21 5-21		x 22-24 18-21	M 0-2 G 0-4 P 55-87	3
KWOK KEK HAR (SIN) Michiko Hakoda (JPN)	x 14-21 9-21	O 24-22 21-18		M 1-1 G 2-2 P 68-82	2

## Women's Doubles 120+ Final Tournament

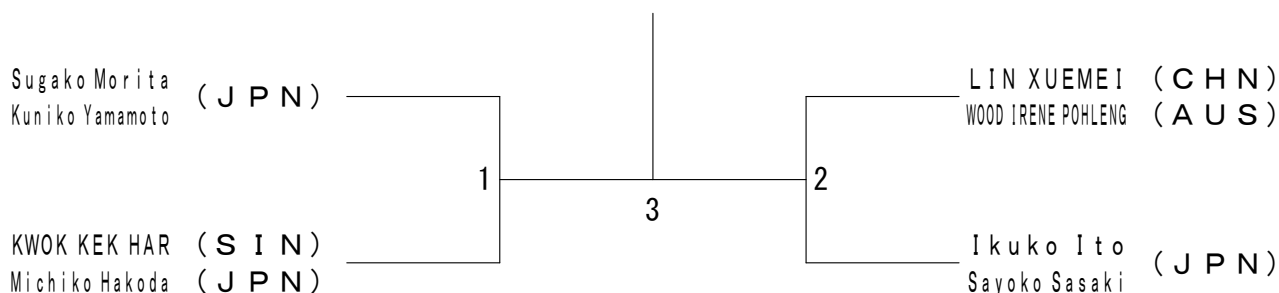

# Mizuno OMOTENASHI Cup Japan

3-5 May 2019 Yuri Honjo City

Women's Doubles 130+ Group A	Yuriko Sumiko	Haruko Mitsue	Kiyoko Masuyo	W-L	Rank
Yuriko Okemoto (JPN) Sumiko Kaneko (JPN)		x 7-21 13-21	○ 21-11 21-15	M 1-1 G 2-2 P 62-68	2
Haruko Asakoshi (JPN) Mitsue Murota (JPN)	○ 21-7 21-13		○ 21-18 21-15	M 2-0 G 4-0 P 84-53	1
Kiyoko Kawabata (JPN) Masuyo Nakamura (JPN)	x 11-21 15-21	x 18-21 15-21		M 0-2 G 0-4 P 59-84	3

Women's Doubles 130+ Group B	Yoshiko Mitsue	Akiko Kiyoko	L I N L O	W-L	Rank
Yoshiko Tago (JPN) Mitsue Matsumoto (JPN)		○ 21-9 21-5	○ 21-10 21-10	M 2-0 G 4-0 P 84-34	1
Akiko Nikaido (JPN) Kiyoko Furuhashi (JPN)	x 9-21 5-21		○ 21-13 21-9	M 1-1 G 2-2 P 56-64	2
LIN XUEMEI (HKG) LO SIU CHUN (HKG)	x 10-21 10-21	x 13-21 9-21		M 0-2 G 0-4 P 42-84	3

## Women's Doubles 130+ Final Tournament

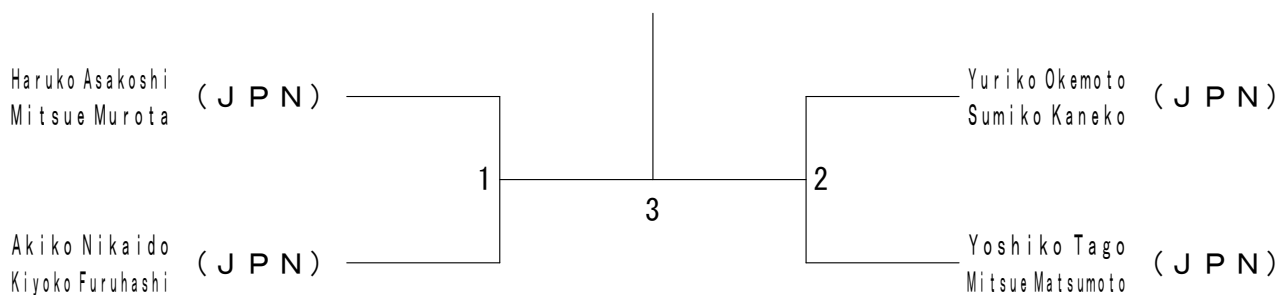

# Mizuno OMOTENASHI Cup Japan

3-5 May 2019 Yuri Honjo City

Mixed Doubles 70+ Group A	Boonsak Kaoru	Hiromasa Yui	Koichi Sayaka	Takashi Miwako	Hiroyuki Hisayo	W-L	Rank
Boonsak Ponsana (THA) Kaoru Takeuchi (JPN)		○ 23-21 21-12	○ 21-13 21-12	○ 21-13 19-21 21-12	○ 21- 6 21- 6	M 4-0 G 8-1 P 189-116	1
Hiromasa Akutsu (JPN) Yui Minagawa	x 21-23 12-21		x 21-11 14-21 7-21	○ 21-13 21-18	○ 21- 6 21- 6	M 2-2 G 5-4 P 159-140	2
Koichi Ozaki (JPN) Sayaka Nunome	x 13-21 12-21	○ 11-21 21-14 21- 7		x 21-14 11-21 12-21	○ 21-13 21-11	M 2-2 G 5-5 P 164-164	4
Takashi Ogawa (JPN) Miwako Moriyama	x 13-21 21-19 12-21	x 13-21 18-21	○ 14-21 21-11 21-12		○ 21- 4 21- 7	M 2-2 G 5-5 P 175-158	3
Hiroyuki Yano (JPN) Hisayo Yano	x 6-21 6-21	x 6-21 6-21	x 13-21 11-21	x 4-21 7-21		M 0-4 G 0-8 P 59-168	5

Mixed Doubles 70+ Group B	Hirofumi Kaori	Tetsushi Sayaka	Tadawo Ai	Atsushi Junko	Tomoya Punvadee	W-L	Rank
Hirofumi Fujino (JPN) Kaori Mori		○ 21-12 18-21 21-19	○ 21- 7 21-10	○ 21- 9 21- 5	○ 21- 4 21- 3	M 4-0 G 8-1 P 186-90	1
Tetsushi Minaguchi (JPN) Sayaka Minaguchi	x 12-21 21-18 19-21		○ 21- 9 21-14	○ 21-11 21- 7	○ 21-12 21- 6	M 3-1 G 7-2 P 178-119	2
Tadawo Kikuchi (JPN) Ai Oshima	x 7-21 10-21	x 9-21 14-21		x 21-13 14-21 15-21	○ 21-11 21-14	M 1-3 G 3-6 P 132-164	4
Atsushi Yamada (JPN) Junko Yamada	x 9-21 5-21	x 11-21 7-21	○ 13-21 21-14 21-15		○ 17-21 21-16 21-18	M 2-2 G 4-6 P 146-189	3
Tomoya Saka (JPN) Punvadee Saka	x 4-21 3-21	x 12-21 6-21	x 11-21 14-21	x 21-17 16-21 18-21		M 0-4 G 1-8 P 105-185	5

## Mixed Doubles 70+ Final Tournament

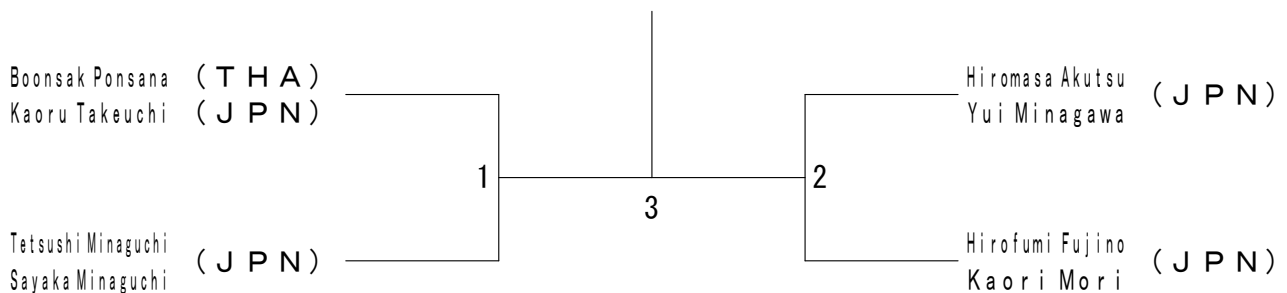

# Mizuno OMOTENASHI Cup Japan

3-5 May 2019 Yuri Honjo City

Mixed Doubles 80+ Group A	Josemari Miyuki	Tomoya Maki	Takeshi Noriko	W-L	Rank
Josemari Fujimoto Miyuki Kusanagi (JPN)		○ 21-11 21-18	○ 19-21 21-4 21-10	M 2-0 G 4-1 P 103-64	1
Tomoya Jin Maki Jin (JPN)	× 11-21 18-21		× 11-21 9-21	M 0-2 G 0-4 P 49-84	3
Takeshi Takayanagi Noriko Sanada (JPN)	× 21-19 4-21 10-21	○ 21-11 21-9		M 1-1 G 3-2 P 77-81	2

Mixed Doubles 80+ Group B	Jun Aiko	Masaharu Ayumi	HUANG CHEN	Manabu Ryoko	W-L	Rank
Jun Takemura Aiko Miyamura (JPN)		○ 21-14 21-16	○ 22-20 21-10	○ 21-15 15-21 21-15	M 3-0 G 6-1 P 142-111	1
Masaharu Okawara Ayumi Takakura (JPN)	× 14-21 16-21		○ 21-15 21-16	○ 21-16 21-11	M 2-1 G 4-2 P 114-100	2
HUANG Hu CHEN Lili (CHN)	× 20-22 10-21	× 15-21 16-21		× 12-21 19-21	M 0-3 G 0-6 P 92-127	4
Manabu Sugiura Ryoko Hongo (JPN)	× 15-21 21-15 15-21	× 16-21 11-21	○ 21-12 21-19		M 1-2 G 3-4 P 120-130	3

## Mixed Doubles 80+ Final Tournament

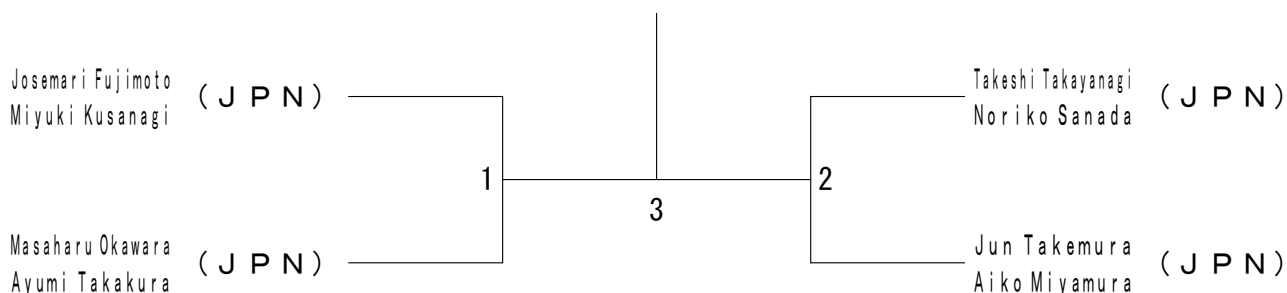

# Mizuno OMOTENASHI Cup Japan

3-5 May 2019 Yuri Honjo City

Mixed Doubles 90+ Group A	Naruthum Sanae	Hideyuki Manami	Mitsumasa Mikoto	Toyokazu Shoko	Hideo Naomi	W - L	Rank
Naruthum Surakkhaka (THA) Sanae Tamura (JPN)		○ 21-11 21-10	○ 21- 8 21-10	○ 21-12 21- 4	○ 21-17 21-15	M 4-0 G 8-0 P 168-87	1
Hideyuki Yokoyama (JPN) Manami Ito	x 11-21 10-21		○ 21-18 21- 9	○ 21- 9 21-15	x 17-21 14-21	M 2-2 G 4-4 P 136-135	3
Mitsumasa Negishi (JPN) Mikoto Kashimura	x 8-21 10-21	x 18-21 9-21		○ 21-15 21-17	x 13-21 6-21	M 1-3 G 2-6 P 106-158	4
Toyokazu Sasaki (JPN) Shoko Miura	x 12-21 4-21	x 9-21 15-21	x 15-21 17-21		x 8-21 13-21	M 0-4 G 0-8 P 93-168	5
Hideo Oyama (JPN) Naomi Akutsu	x 17-21 15-21	○ 21-17 21-14	○ 21-13 21- 6	○ 21- 8 21-13		M 3-1 G 6-2 P 158-113	2

Mixed Doubles 90+ Group B	Pracha Angela	So Ayumi	Toshikazu Noriko	Masanori Junko	W - L	Rank
Pracha Wannawichitr (THA) Angela Charumilinda		○ 21- 5 21- 7	○ 21- 7 25-23	○ 21-10 21- 8	M 3-0 G 6-0 P 130-60	1
So Tsuchiya (JPN) Ayumi Asai	x 5-21 7-21		○ 12-21 21-19 21-18	○ 21-15 19-21 21-19	M 2-1 G 4-4 P 127-155	2
Toshikazu Kojima (JPN) Noriko Ushigome	x 7-21 23-25	x 21-12 19-21 18-21		○ 21-18 21-13	M 1-2 G 3-4 P 130-131	3
Masanori Sato (JPN) Junko Matsumoto	x 10-21 8-21	x 15-21 21-19 19-21	x 18-21 13-21		M 0-3 G 1-6 P 104-145	4

Mixed Doubles 90+ Group C	Wattana Sirirat	TAN Kumiko	Kenichi Taeko	Masaharu Shino	Sen Yoko	W - L	Rank
Wattana Ampunsuwan (THA) Sirirat Wannawichitr		x 21-12 12-21 14-21	x 10-21 9-21	x 18-21 24-22 17-21	○ 21-13 21-18	M 1-3 G 4-6 P 167-191	4
TAN TIEAN HOW (MAS) Kumiko Kushiya (JPN)	○ 12-21 21-12 21-14		x 17-21 15-21	○ 20-22 21-11 21-14	○ 21-11 21-18	M 3-1 G 6-4 P 190-165	2
Kenichi Asano (JPN) Taeko Takemoto	○ 21-10 21- 9	○ 21-17 21-15		○ 21-13 21- 9	○ 21- 7 21- 9	M 4-0 G 8-0 P 168-89	1
Masaharu Ito (JPN) Shino Ito	○ 21-18 22-24 21-17	x 22-20 11-21 14-21	x 13-21 9-21		○ 21-18 21-18	M 2-2 G 5-5 P 175-199	3
Sen Tsuchiya (JPN) Yoko Hara	x 13-21 18-21	x 11-21 18-21	x 7-21 9-21	x 18-21 18-21		M 0-4 G 0-8 P 112-168	5

Mixed Doubles 90+ Group D	Keiichi Chika	TAM MAK	Masakazu Yumi	Tomoya Chikako	Ryuichi Kayoko	W - L	Rank
Keiichi Tanaka (JPN) Chika Tanifuji		○ 23-21 21-10	x 13-21 19-21	○ 21-12 21-17	○ 21- 6 21- 3	M 3-1 G 6-2 P 160-111	2
TAM CHIU MAN CHARLES (HKG) MAK WAI FONG	x 21-23 10-21		x 11-21 19-21	○ 21-15 21-16	○ 21- 7 21-15	M 2-2 G 4-4 P 145-139	3
Masakazu Rokutan (JPN) Yumi Otsuka	○ 21-13 21-19	○ 21-11 21-19		○ 21- 8 21-19	○ 21- 2 21- 4	M 4-0 G 8-0 P 168-95	1
Tomoya Ogata (JPN) Chikako Tanabe	x 12-21 17-21	x 15-21 16-21	x 8-21 19-21		○ 21-19 21- 6	M 1-3 G 2-6 P 129-151	4
Ryuichi Kobayashi (JPN) Kayoko Wakimoto	x 6-21 3-21	x 7-21 15-21	x 2-21 4-21	x 19-21 6-21		M 0-4 G 0-8 P 62-168	5

## Mixed Doubles 90+ Final Tournament

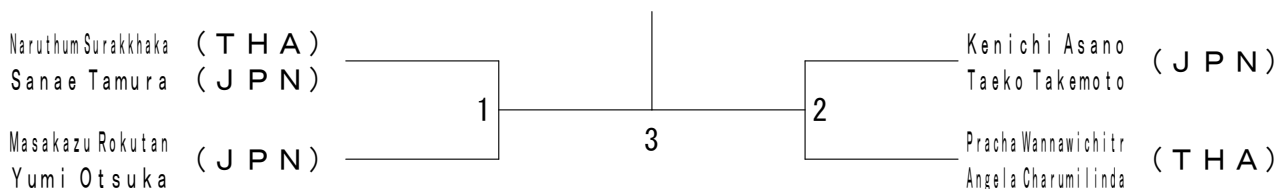



# Mizuno OMOTENASHI Cup Japan

3-5 May 2019 Yuri Honjo City

Mixed Doubles 100+ Group A	Aroonprasertkul Lee	Toshiaki Yumiko	WONG HU	WONG LIU	Tsumoru Chie	W - L	Rank
Aroonprasertkul Chatsada (THA) Lee Miu Nei Winnie (HKG)		x 15-21 4-21	x 11-21 13-21	x 21-16 13-21 20-22	o 21-14 21- 7	M 1-3 G 3-6 P 139-164	4
Toshiaki Ichii (JPN) Yumiko Takeda	o 21-15 21- 4		x 19-21 21-10 18-21	o 21-17 16-21 21-16	o 21-10 21-13	M 3-1 G 7-3 P 200-148	2
WONG Shu Ching (HKG) HU Shu Zhen (CHN)	o 21-11 21-13	o 21-19 10-21 21-18		o 21- 6 23-21	o 21-10 21- 6	M 4-0 G 8-1 P 180-125	1
WONG KONG KAY (SIN) LIU YALIAN	o 16-21 21-13 22-20	x 17-21 21-16 16-21	x 6-21 21-23		o 21-10 21-12	M 2-2 G 5-5 P 182-178	3
Tsumoru Kojima (JPN) Chie Kojima	x 14-21 7-21	x 10-21 13-21	x 10-21 6-21	x 10-21 12-21		M 0-4 G 0-8 P 82-168	5

Mixed Doubles 100+ Group B	YAN TANG	Koji Ryoko	Takeshi Ikuko	Sit Kwok	W - L	Rank
YAN JIANPING (CHN) TANG RONG		x x-	x 22-20 13-21 13-21	x x-	M 0-3 G 1-6 P 48-146	4
Koji Tanaka (JPN) Ryoko Kuroda	o -x		x 15-21 13-21	o 21-18 21-13	M 2-1 G 4-2 P 112-73	2
Takeshi Masaoka (JPN) Ikuko Tsujino	o 20-22 21-13 21-13	o 21-15 21-13		o 21-12 21-16	M 3-0 G 6-1 P 146-104	1
Sit Wai Keung (HKG) Kwok Chi Ping	o -x	x 18-21 13-21	x 12-21 16-21		M 1-2 G 2-4 P 101-84	3

Mixed Doubles 100+ Group C	YANG WANG	Taro Emi	Toshio Sugako	Toshiaki Ritsuko	Yutaka Hiroko	W - L	Rank
YANG QIANG (CHN) WANG HONG		x 11-21 18-21	x x-	x 15-21 7-21	o 21-11 21-10	M 1-3 G 2-6 P 93-147	4
Taro Higashi (JPN) Emi Higashi	o 21-11 21-18		o 21-12 21-12	x 21-18 10-21 17-21	o 21-10 21- 6	M 3-1 G 7-2 P 174-129	2
Toshio Okada (JPN) Sugako Keisyu	o -x	x 12-21 12-21		x 21-19 12-21 10-21	o 21-11 21-13	M 2-2 G 5-4 P 151-127	3
Toshiaki Nakajima (JPN) Ritsuko Sato	o 21-15 21- 7	o 18-21 21-10 21-17	o 19-21 21-12 21-10		o 21-11 21- 4	M 4-0 G 8-2 P 205-128	1
Yutaka Magara (JPN) Hiroko Takaki	x 11-21 10-21	x 10-21 6-21	x 11-21 13-21	x 11-21 4-21		M 0-4 G 0-8 P 76-168	5

Mixed Doubles 100+ Group D	Liao Zhao	Kotaro CHENG	Yasuyuki Mariko	Kazuyuki Hideko	Yoichi Mutsumi	W - L	Rank
Liao wei (MAC) Zhao Hui Mei		x x-	x x-	x x-	x x-	M 0-4 G 0-8 P 0-168	5
Kotaro Shiraki (JPN) CHENG LAI KAM (HKG)	o -x		x 6-21 18-21	o 21-10 15-21 21-14	o 21-19 21-11	M 3-1 G 6-3 P 165-117	2
Yasuyuki Watabe (JPN) Mariko Numazawa	o -x	o 21- 6 21-18		o 21-11 21-14	o 21- 7 21- 8	M 4-0 G 8-0 P 168-64	1
Kazuyuki Tano (JPN) Hideko Tano	o -x	x 10-21 21-15 14-21	x 11-21 14-21		o 21-13 21-18	M 2-2 G 5-4 P 154-130	3
Yoichi Miyamoto (JPN) Mutsumi Miyamoto	o -x	x 19-21 11-21	x 7-21 8-21	x 13-21 18-21		M 1-3 G 2-6 P 118-126	4

## Mixed Doubles 100+ Final Tournament



# Mizuno OMOTENASHI Cup Japan

3-5 May 2019 Yuri Honjo City

Mixed Doubles 110+ Group A	Narong Juthatip	Katsumi Manami	Tomoaki keiko	Tomohiko Mitsue	Katsumi Kiyomi	W-L	Rank
Narong Vanichitsarakul Juthatip Banjongsilp (THA)		○ 21-12 21-16	○ 21-17 21-10	○ 19-21 21-12 21-8	○ 21-6 21-12	M 4-0 G 8-1 P 187-114	1
Katsumi Tanaka Manami Ochiai (JPN)	x 12-21 16-21		x 15-21 19-21	○ 21-19 16-21 21-13	○ 21-13 21-11	M 2-2 G 4-5 P 162-161	4
Tomoaki Yaso keiko Serino (JPN)	x 17-21 10-21	○ 21-15 21-19		x 8-21 17-21	○ 21-13 21-7	M 2-2 G 4-4 P 136-138	3
Tomohiko Goto Mitsue Tanaka (JPN)	x 21-19 12-21 8-21	x 19-21 21-16 13-21	○ 21-8 21-17		○ 21-12 21-5	M 2-2 G 6-4 P 178-161	2
Katsumi Shimotada Kiyomi Tada (JPN)	x 6-21 12-21	x 13-21 11-21	x 13-21 7-21	x 12-21 5-21		M 0-4 G 0-8 P 79-168	5

Mixed Doubles 110+ Group B	LIM LIU	Pan Lin	Syuichi Michiko	Senichi Yumiko	Toru Mayumi	W-L	Rank
LIM CHOONG KHAI LIU CHUN HUA (SIN)		x 10-21 21-19 19-21	x 11-21 18-21	x 12-21 12-21	x 21-11 18-21 21-23	M 0-4 G 2-8 P 163-200	5
Pan Jia Long Lin Gui Chen (MAC)	○ 21-10 19-21 21-19		x 13-21 15-21	x 21-17 14-21 12-21	x 18-21 24-26	M 1-3 G 3-7 P 178-198	4
Syuichi Matsuo Michiko Hakoda (JPN)	○ 21-11 21-18	○ 21-13 21-15		○ 22-24 21-17 21-18	○ 21-12 21-13	M 4-0 G 8-1 P 190-141	1
Senichi Oba Yumiko Sato (JPN)	○ 21-12 21-12	○ 17-21 21-14 21-12	x 24-22 17-21 18-21		○ 19-21 21-10 21-17	M 3-1 G 7-4 P 221-183	2
Toru Miyano Mayumi Sasakawa (JPN)	○ 11-21 21-18 23-21	○ 21-18 26-24	x 12-21 13-21	x 21-19 10-21 17-21		M 2-2 G 5-5 P 175-205	3

Mixed Doubles 110+ Group C	ANG LIEW	Tsang Chow	Yoshikazu Ikuko	Masayuki Ryoko	Toshiyuki Koko	W-L	Rank
ANG SOO CHENG LIEW SAM FAH (SIN)		x 9-21 17-21	○ -x	○ 21-11 21-18	○ 21-17 21-16	M 3-1 G 6-2 P 152-104	2
Tsang Ki Man Chow Shuk Han (HKG)	○ 21-9 21-17		○ -x	○ 21-13 21-11	○ 21-11 21-14	M 4-0 G 8-0 P 168-75	1
Yoshikazu Ezaki Ikuko Ito (JPN)	x x-	x x-		x x-	x x-	M 0-4 G 0-8 P 0-168	5
Masayuki Fujisawa Ryoko Yanagimura (JPN)	x 11-21 18-21	x 13-21 11-21	○ -x		○ 21-18 21-10	M 2-2 G 4-4 P 137-112	3
Toshiyuki Kakehata Koko Sasaki (JPN)	x 17-21 16-21	x 11-21 14-21	○ -x	x 18-21 10-21		M 1-3 G 2-6 P 128-126	4

# Mizuno OMOTENASHI Cup Japan

3-5 May 2019 Yuri Honjo City

Mixed Doubles 110+ Group D	XIE WANG	Kwan Cheung	Naoki Sotomi	Masaya Taiko	W-L	Rank
XIE LUN LI (SIN) WANG GUI CHAI		x 14-21 14-21	x 8-21 15-21	o 21-16 21-12	M 1-2 G 2-4 P 93-112	3
Kwan Sai Wing Louis (HKG) Cheung Yuk Lin Jenny	o 21-14 21-14		x 17-21 21-19 13-21	o 21- 8 21- 3	M 2-1 G 5-2 P 135-100	2
Naoki Kobayashi (JPN) Sotomi Yasuda	o 21- 8 21-15	o 21-17 19-21 21-13		o 21-18 21-12	M 3-0 G 6-1 P 145-104	1
Masaya Masuda (JPN) Taiko Nobe	x 16-21 12-21	x 8-21 3-21	x 18-21 12-21		M 0-3 G 0-6 P 69-126	4

Mixed Doubles 110+ Group E	JAFREE Kuniko	TANG CHAN	Makoto Wakako	Fumitaka Masako	W-L	Rank
JAFREE BIN RAMLY (MAS) Kuniko Yamamoto (JPN)		o 21-13 21- 6	o 21-10 14-21 21- 7	o 21-16 21- 7	M 3-0 G 6-1 P 140-80	1
TANG SIMON YAU SHING (HKG) CHAN SIU YING	x 13-21 6-21		o 21-19 19-21 21- 9	o 21-18 7-21 21-17	M 2-1 G 4-4 P 129-147	2
Makoto Ataka (JPN) Wakako Otsuka	x 10-21 21-14 7-21	x 19-21 21-19 9-21		o 26-28 21-13 21-19	M 1-2 G 4-5 P 155-177	3
Fumitaka Sato (JPN) Masako Sato	x 16-21 7-21	x 18-21 21- 7 17-21	x 28-26 13-21 19-21		M 0-3 G 2-6 P 139-159	4

## Mixed Doubles 110+ Final Tournament

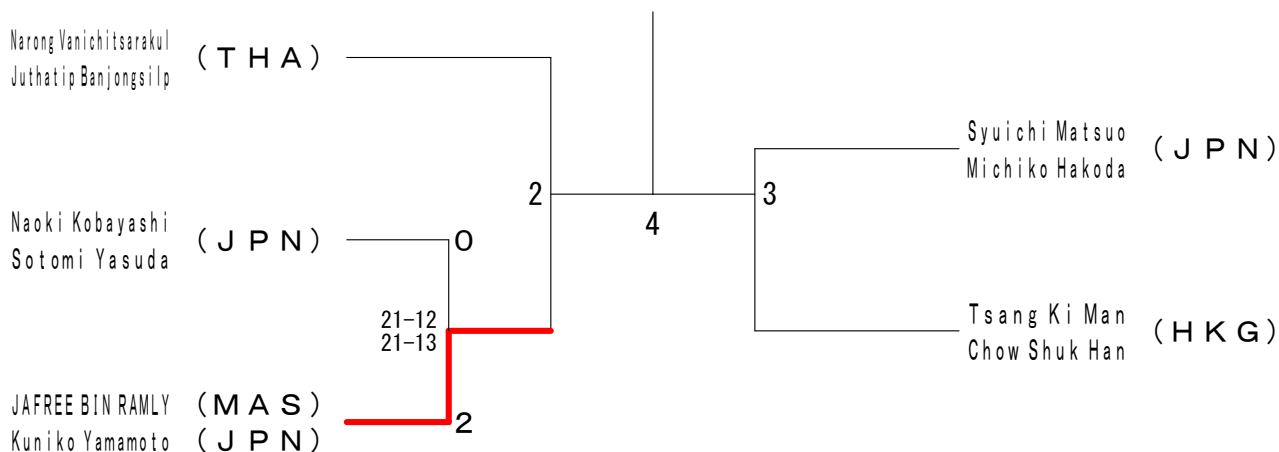

# Mizuno OMOTENASHI Cup Japan

3-5 May 2019 Yuri Honjo City

Mixed Doubles 120+ Group A	G u Zhou	L I E YANG	LEE WOOD	Kwong N g	Takeyoshi Yoko	W-L	Rank
Gu Yang Xiang (MAC) Zhou Jian Yang		x 12-21 17-21	x 16-21 21-13 16-21	o 21- 6 21-13	x 12-21 13-21	M 1-3 G 3-6 P 149-158	4
LIE JUN MEN (SIN) YANG WEN LAN	o 21-12 21-17		x 15-21 21-17 19-21	o 21- 9 21-10	x 13-21 15-21	M 2-2 G 5-4 P 167-149	3
LEE YUEN SANG (HKG) WOOD IRENE POHLENG (AUS)	o 21-16 13-21 21-16	o 21-15 17-21 21-19		o 21- 7 21- 9	x 18-21 14-21	M 3-1 G 6-4 P 188-166	2
Kwong Ying Yau Kanny (HKG) Ng Kit Ching	x 6-21 13-21	x 9-21 10-21	x 7-21 9-21		x 5-21 12-21	M 0-4 G 0-8 P 71-168	5
Takeyoshi Tanimura (JPN) Yoko Kanagami	o 21-12 21-13	o 21-13 21-15	o 21-18 21-14	o 21- 5 21-12		M 4-0 G 8-0 P 168-102	1

Mixed Doubles 120+ Group B	Liang Chen	TAN Y U	ZEE Sugako	L im Mayumi	Takeishi Sachiko	W-L	Rank
Liang Zhi Xiong (MAC) Chen Hui Ai		x 13-21 14-21	x 13-21 7-21	x 15-21 10-21	x 14-21 18-21	M 0-4 G 0-8 P 104-168	5
TAN KIAN BAN (SIN) YU LAN	o 21-13 21-14		x 8-21 10-21	x 8-21 9-21	x 13-21 10-21	M 1-3 G 2-6 P 100-153	4
ZEE JEFFREY JAMIN (HKG) Sugako Morita (JPN)	o 21-13 21- 7	o 21- 8 21-10		o 21-16 21-18	o 21-12 21-12	M 4-0 G 8-0 P 168-96	1
Lim yow song (MAS) Mayumi Miura (JPN)	o 21-15 21-10	o 21- 8 21- 9	x 16-21 18-21		x 19-21 21-12 12-21	M 2-2 G 5-4 P 170-138	3
Takeishi Saito (JPN) Sachiko Takahashi	o 21-14 21-18	o 21-13 21-10	x 12-21 12-21	o 21-19 12-21 21-12		M 3-1 G 6-3 P 162-149	2

Mixed Doubles 120+ Group C	L iu L iu	ONG Lam	CHEN WANG	Daniel Yoshiko	TAN KWOK	W-L	Rank
Liu Lin Shan (MAC) Liu Xi Ling		x 16-21 23-21 17-21	o 21-19 21-16	x 14-21 17-21	o 21-19 21-15	M 2-2 G 5-4 P 171-174	3
ONG THEN LIN (MAS) Lam Fung Sheung (HKG)	o 21-16 21-23 21-17		o 21-15 21- 9	o 21-11 21-13	o 21- 8 21- 6	M 4-0 G 8-1 P 189-118	1
CHEN AN ZE (SIN) WANG	x 19-21 16-21	x 15-21 9-21		x 8-21 17-21	o 21-16 22-20	M 1-3 G 2-6 P 127-162	4
Daniel Wang (USA) Yoshiko Tago (JPN)	o 21-14 21-17	x 11-21 13-21	o 21- 8 21-17		o 21- 7 13-21 22-20	M 3-1 G 6-3 P 164-146	2
TAN KIAT HOCK (MAS) KWOK KEK HAR (SIN)	x 19-21 15-21	x 8-21 6-21	x 16-21 20-22	x 7-21 21-13 20-22		M 0-4 G 1-8 P 132-183	5

# Mizuno OMOTENASHI Cup Japan

3-5 May 2019 Yuri Honjo City

Mixed Doubles 120+ Group D	Qin Liao	VICTOR NATALIE	Bovornovadep Haruko	Thomas Sayoko	Johnson Atsushi	W-L	Rank
Qin Xiong Hui (MAC) Liao Na Ling		x x-	x x-	x x-	x x-	M 0-4 G 0-8 P 0-168	5
VICTOR SIM (SIN) NATALIE ONG LAY GUAT	○ -x		○ 21-14 21-16	○ 21-11 21-13	○ 21-9 21-16	M 4-0 G 8-0 P 168-79	1
Bovornovadep Devakula (THA) Haruko Asakoshi (JPN)	○ -x	x 14-21 16-21		x 14-21 18-21	○ 21-13 21-16	M 2-2 G 4-4 P 146-113	3
Thomas Lui (USA) Sayoko Sasaki (JPN)	○ -x	x 11-21 13-21	○ 21-14 21-18		○ 21-14 21-17	M 3-1 G 6-2 P 150-105	2
Johnson Tad (JPN) Atsushi Sasaki	○ -x	x 9-21 16-21	x 13-21 16-21	x 14-21 17-21		M 1-3 G 2-6 P 127-126	4

## Mixed Doubles 120+ Final Tournament

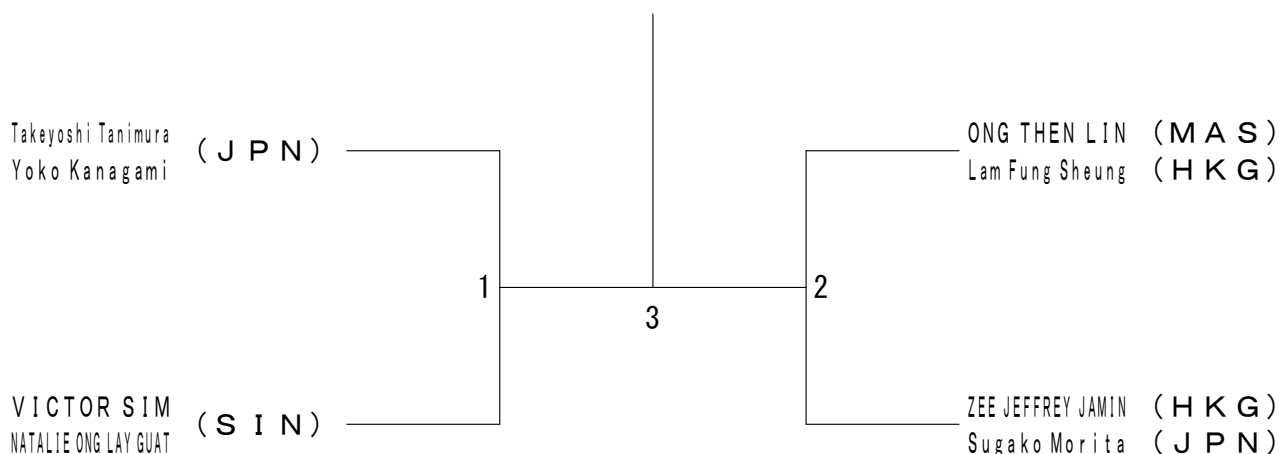

# Mizuno OMOTENASHI Cup Japan

3-5 May 2019 Yuri Honjo City

Mixed Doubles 130+ Group A	Masaki Kiyoko	Chua Sumiko	Boon Mitsue	Fumio Hisae	W-L	Rank
Masaki Furuhashi (JPN) Kiyoko Furuhashi		x 16-21 15-21	o 21-10 19-21 21-16	o 21-10 21- 7	M 2-1 G 4-3 P 134-106	2
Chua Koh Keong (MAS) Sumiko Kaneko (JPN)	o 21-16 21-15		o 21- 9 21-13	o 21- 9 21- 6	M 3-0 G 6-0 P 126-68	1
Boon S Teoh (AUS) Mitsue Matsumoto (JPN)	x 10-21 21-19 16-21	x 9-21 13-21		o 21-19 21-12	M 1-2 G 3-4 P 111-134	3
Fumio Kurota (JPN) Hisae Teramura	x 10-21 7-21	x 9-21 6-21	x 19-21 12-21		M 0-3 G 0-6 P 63-126	4

Mixed Doubles 130+ Group B	Goh Yuriko	LEE LO	Seri Mitsue	Makoto Akiko	W-L	Rank
Goh Kim Chuan (MAS) Yuriko Okemoto (JPN)		x 15-21 20-22	x 17-21 12-21	x 13-21 15-21	M 0-3 G 0-6 P 92-127	4
LEE YUEN SANG (HKG) LO SIU CHUN	o 21-15 22-20		o 21-16 15-21 21-12	x 21-17 13-21 15-21	M 2-1 G 5-3 P 149-143	2
Seri Chintanaseri (THA) Mitsue Murota (JPN)	o 21-17 21-12	x 16-21 21-15 12-21		x 14-21 19-21	M 1-2 G 3-4 P 124-128	3
Makoto Goto (JPN) Akiko Nikaido	o 21-13 21-15	o 17-21 21-13 21-15	o 21-14 21-19		M 3-0 G 6-1 P 143-110	1

## Mixed Doubles 130+ Final Tournament

